

Tube clamps cross aluminum, metric

Item description/product images

METRIC
Parts

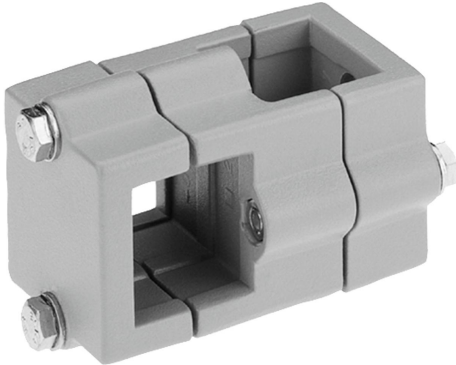

Description

Material:

Cast aluminum.
Screws and nuts steel.

Version:

Vibratory ground.
Screws and nuts electro zinc-plated.

On request:

Adjustable handles for tightening.

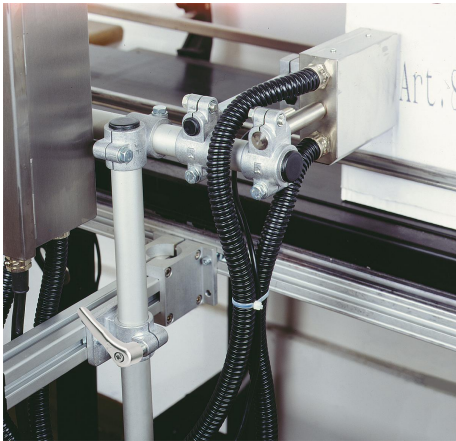

Tube clamps cross aluminum, metric

Item description/product images

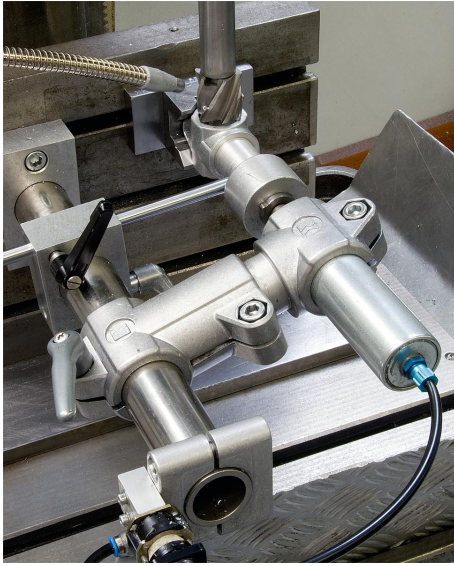

Drawings

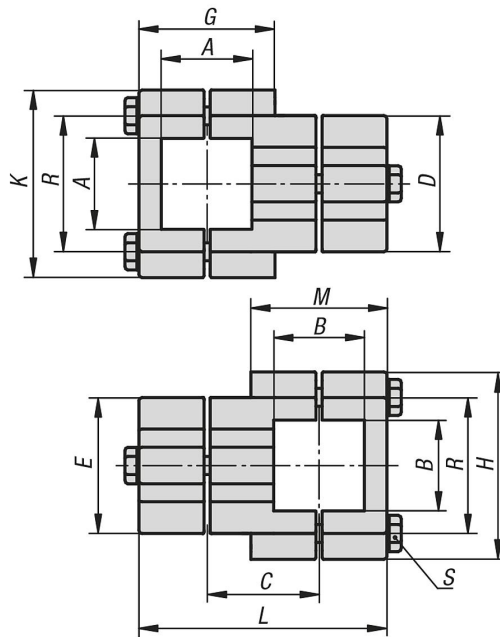

Item No.	A	B	C	D	E	G	H	K	L	M	R	S
K0473.523030	30,2	30,2	38	45	45	44	64	64	83	44	46	M8x45
K0473.524040	40,3	40,3	50	60	60	61	75	75	111	61	57	M8x60