

## Quarter-turn locks, stainless steel, small version

### Item description/product images



### Description

**Material:**

Housing and fastening nut, stainless steel 1.4404.

Actuator 1.4401.

O-ring NBR.

**Version:**

Bright.

**Note:**

The quarter turn lock can be installed pre-assembled.

For right or left use.

Water and dust protected acc. to IP65 to DIN EN 60529.

Please order required tongue version separately. Every tongue can be combined with every housing.

**Drawing reference:**

Actuation:

- a) square 7 mm
- b) square 8 mm
- c) double lug 3 mm
- d) double lug 5 mm
- e) wing grip

- 1) O-ring

Quarter-turn locks, stainless steel, small version

Drawings

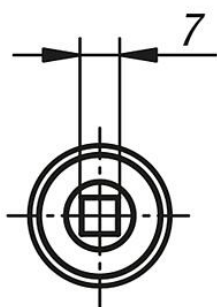
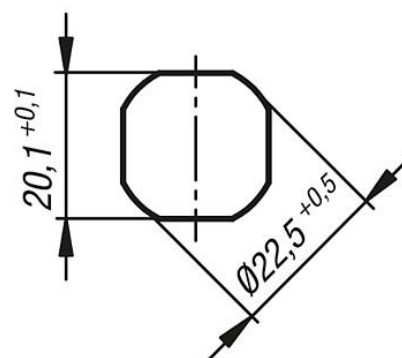
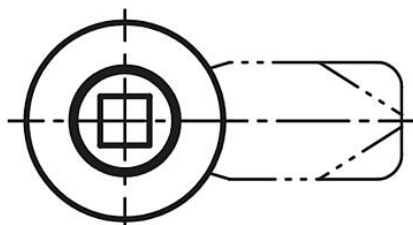
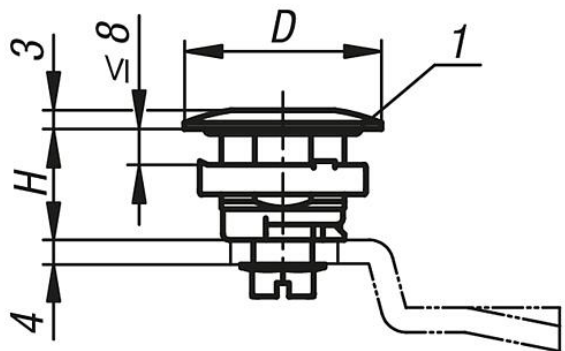

a

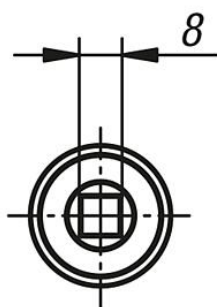

b

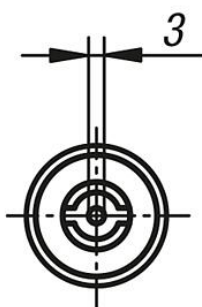

c

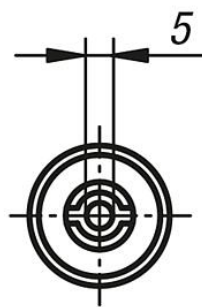

d

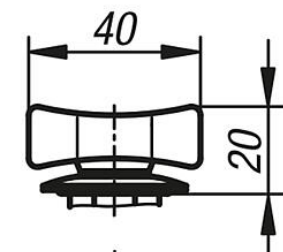

e

Order No.	Actuation	D	H
K1339.1718	square 7 mm	32	18
K1339.1818	square 8 mm	32	18
K1339.4318	double bit 3 mm	32	18
K1339.4518	double bit 5 mm	32	18
K1339.0018	wing grip	32	18

